

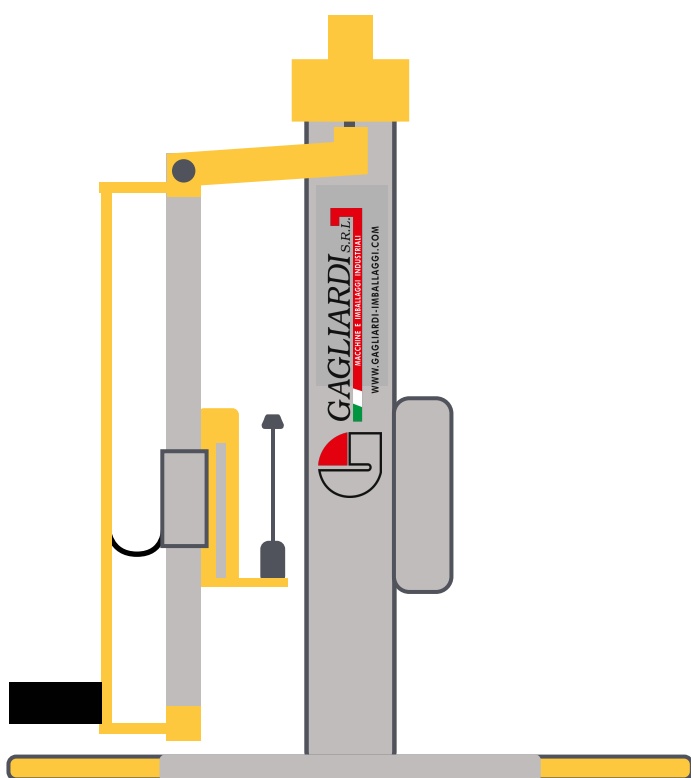

GAGLIARDI S.R.L.
MACCHINE E IMBALLAGGI INDUSTRIALI

WWW.GAGLIARDI-IMBALLAGGI.COM



LYBRA

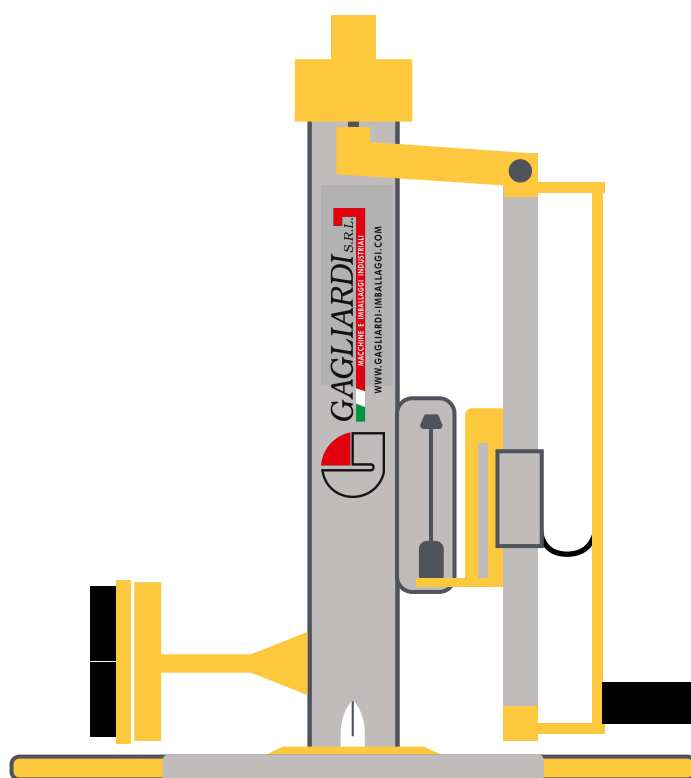

LYBRA AUTO

SEMI AUTOMATIC PALLET WRAPPER
MAINTENANCE FREE
EASY INSTALLATION

**Semi automatic turntable
for wrapping pallets with stretch film**

LYBRA

Input: 230 Volt
1 PHASE



LYBRA AUTO

Input: 230 Volt
1 PHASE

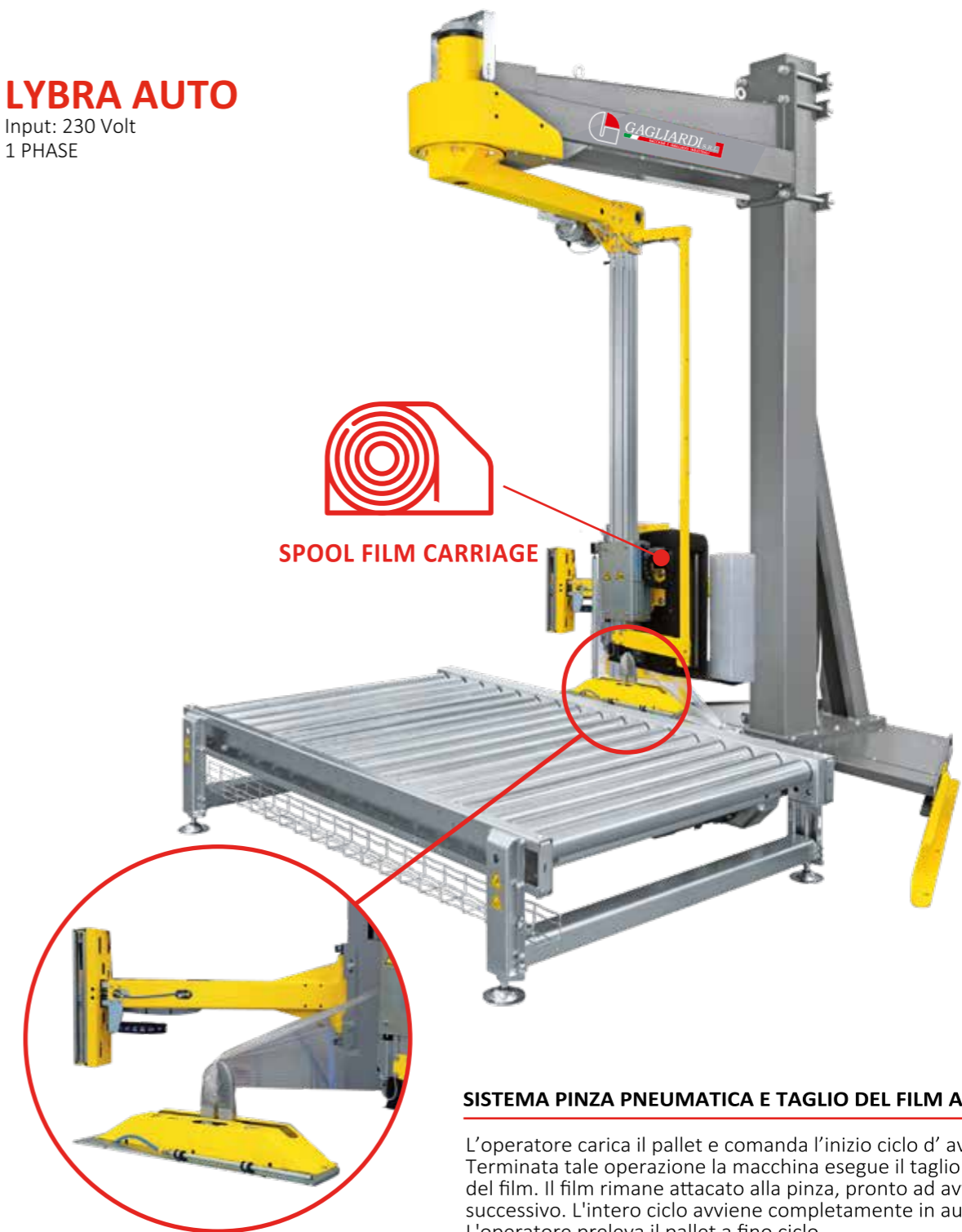

SISTEMA PINZA PNEUMATICA E TAGLIO DEL FILM A FINE CICLO

L'operatore carica il pallet e comanda l'inizio ciclo d'avvolgimento. Terminata tale operazione la macchina esegue il taglio e la pinzatura del film. Il film rimane attaccato alla pinza, pronto ad avvolgere il pallet successivo. L'intero ciclo avviene completamente in automatico. L'operatore preleva il pallet a fine ciclo.

PALLET DIMENSIONS

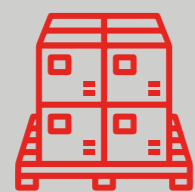
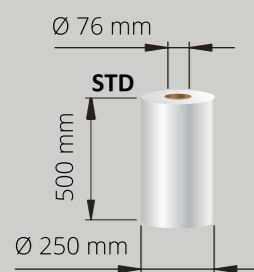

Max: 2000 Kg STD
Max: 3000 Kg OPT

Lybra
H = 2200 STD
H = 2500 OPT
H = 3000 OPT

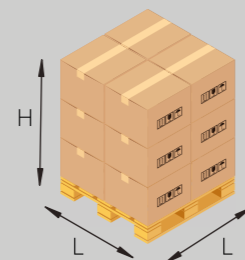

L=1200x1200 mm ↗ 1700 max STD
L=1400x1400 mm ↗ 1980 max STD
L=1500x1500 mm ↗ 2120 max STD
L=1600x1600 mm ↗ 2260 max STD
L=1700x1700 mm ↗ 2400 max STD

APPLICATIONS



LYBRA STATION

Input: 230 Volt
1 PHASE

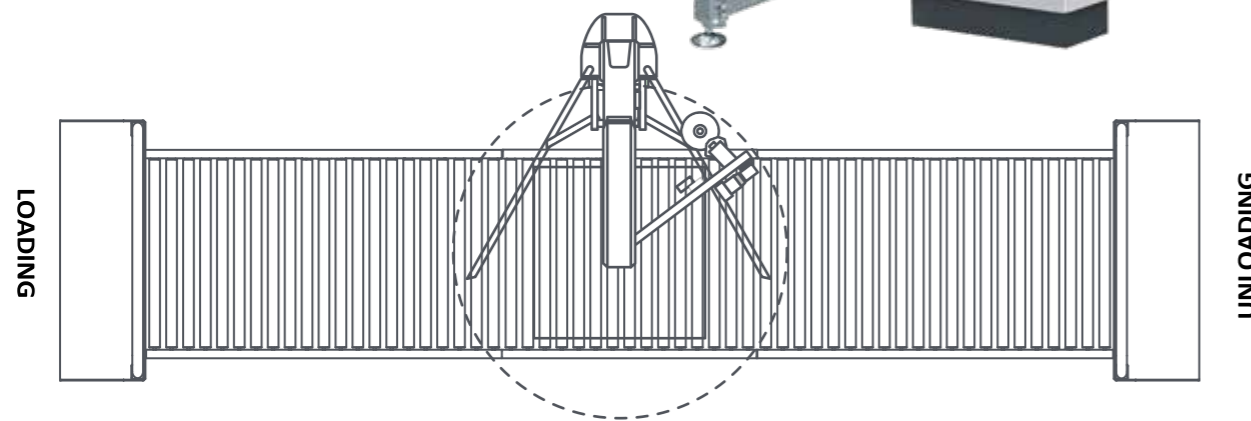

WRAPPING

WRAPPING PROGRAMS

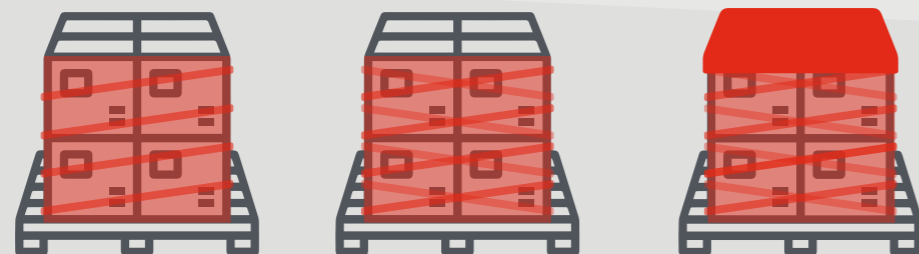

EXCHANGEABLE CARRIAGES



- IT Carrelli porta bobina intercambiabili anche dopo la consegna della macchina con un notevole risparmio.
- EN The carriage can be upgraded even after delivery, to achieve lower costs of ownership.
- FR Le chariot peut être mis à niveau même après la livraison, afin de réduire les coûts de possession.
- DE Austauschbarer Folienschlitten auch nach Auslieferung der Maschine, zur Reduzierung der Betriebskosten
- ES El carro se puede actualizar incluso después de la entrega, para lograr menores costos de propiedad.

ERGONOMIC SOLUTION FOR THE USER



- IT L'attenzione alla sicurezza e al massimo comfort del lavoratore contribuiscono a migliorare la qualità del lavoro, diminuendo lo stress a favore della soddisfazione generale dell'utente
- EN For the highest security and safety of the user and to achieve a better working environment, and higher satisfaction of the user.
- FR Pour la plus grande sécurité et sûreté de l'utilisateur et pour obtenir un meilleur environnement de travail et une plus grande satisfaction de l'utilisateur.
- DE Für höchste Sicherheit des Nutzers, sowie zur Erreichung eines besseren Arbeitsumfelds und Zufriedenheit
- ES Para la mayor seguridad y protección del usuario y para lograr un mejor ambiente de trabajo, y una mayor satisfacción del usuario.

COMMERCIAL COMPONENTS AND INVERTERS AVAILABLE ON THE FREE MARKET



- IT La facilità con cui i nostri componenti sono reperibili sul mercato contribuisce ad abbatterne il prezzo con notevole risparmio per l'utente.
- EN The use of commercial components in all our products means higher reliability and lower costs but also flexibility in terms of materials supply.
- FR La façon dont nous nous approvisionnons et spécifions des niveaux élevés pour les composants de nos produits, signifie que vous bénéficierez de niveaux de fiabilité élevés et constants
- DE Der Einsatz handelsüblicher Komponenten in all unseren Produkten bedeutet höhere Zuverlässigkeit und geringere Kosten, aber auch Flexibilität bei der Materialversorgung.
- ES El uso de componentes comerciales en todos nuestros productos significa mayor confiabilidad y menores costos, pero también flexibilidad en términos de suministro de materiales.

POSSIBILITY TO ADJUST TENSION ON LOAD AND PRE STRETCH IN EVERY STEP OF THE WRAPPING CYCLE

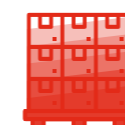

- IT I nostri carrelli offrono la possibilità di regolare in maniera mirata la tensione del film e il pre-stiro in ogni fase dell'avvolgimento.
- EN Our carriages are standard equipped with the possibility to adjust film tension and pre-stretch during every phase of the wrapping process.
- FR Nos chariots sont tous équipés en mode standard avec la possibilité de régler la tension du film et de le pré-étirer à chaque étape du processus d'emballage.
- DE Unsere Folienschlitten sind so konzipiert, dass sowohl die Anlegespannung als auch die Folienvordehnung in jeder Phase des Wickelzyklus regulierbar sind.
- ES Nuestros carros están equipados de serie con la posibilidad de ajustar la tensión de la película y preestirar durante cada fase del proceso de envoltura.



OPERATING PANEL

-Togli il terzo wrapping program
-Modifiche layout come in allegato
-pannello: cancella mytho mytho easy- scrivi :
LYBRA 99 PROGRAMS

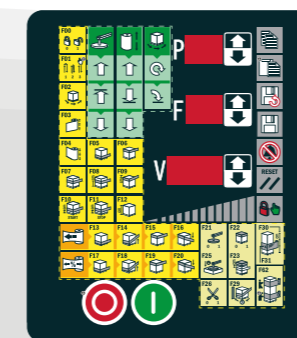

DISPLAY 11" easy to use touch screen

Lybra: 99 PROGRAMS

- IT Pannello di controllo multifunzionale programmabile
- EN Multifunction programmable control panel
- FR Panneau de controle multifonction programmable
- DE Multifunktion programmierbare Systemsteuerung
- ES Panel de control programable multifuncion

SPOOL FILM CARRIAGE

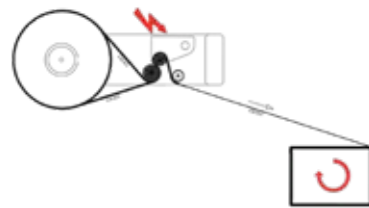

EASY FILM CHANGE

- IT** Cambio film semplificato, altezza di arresto del carrello porta bobina automatico.
- EN** Easy reel change, adjustable service height.
- FR** Changement de bobine facile, hauteur de service réglable.
- DE** Einfacher Folienwechsel in ergonomischer Arbeitshöhe.
- ES** Cambio fácil de bobina, altura de embalaje ajustable.

FE

- IT** Frizione elettromagnetica regolabile da pannello comandi.
- EN** Electromagnetic friction adjustable from control panel.
- FR** Frein électromagnétique réglable depuis le panneau de commande.
- DE** Elektromagnetische Bremse auf Umlenkwalze vom Bedienpult instellbar.
- ES** Fricción electromagnética regulable desde el panel de comandos.

PRS POWER ROLLER STRETCH

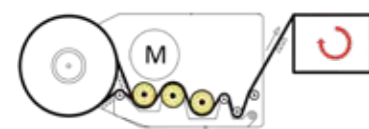

- IT** Sistema di prestiro motorizzato a 3rulli comandato elettronicamente con rapporti intercambiabili: 150- 200- 250%.
- EN** Motorized pre-stretch system with 3 driven rollers electronically controlled with interchangeable ratios: 150- 200- 250%.
- FR** Système de pré-étirage motorisé et asservi à 3 rouleaux, rapports interchangeables: 150- 200- 250%.
- DE** Angetriebener Vordehnssystem mit 3 Vordehnrollen, elektronisch gesteuert mit leicht wechselbarer Zahnradsätzen: 150- 200- 250%.
- ES** Sistema de prestiro motorizado con 3 rodillos, comandado electrónicamente con desarrollos intercambiables: 150- 200- 250%.

PS POWER STRETCH

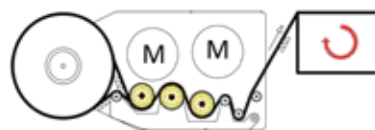

- IT** Sistema di motorizzato a 3 rulli con 2 motori e variazione da 120 a 350% regolabile da quadro comandi.
- EN** Motorized pre-stretch system with 3 driven rollers and 2 motors adjustable between 120 to 350% from control panel.
- FR** Système de pré-étirage motorisé et asservi à 3 rouleaux et 2 moteurs, rapport ajustable de 120 à 350% depuis le panneau de commande.
- DE** Angetriebener Vordehnssystem mit 3 Vordehnrollen und 2 Motoren, stufenlos regelbare Werte zwischen 120 und 350% von Bedienpult.
- ES** Sistema de prestiro motorizado con 3 rodillos y 2 motores, regulable da 120 a 350% desde el panel de comandos.

MEANS OF LOADING

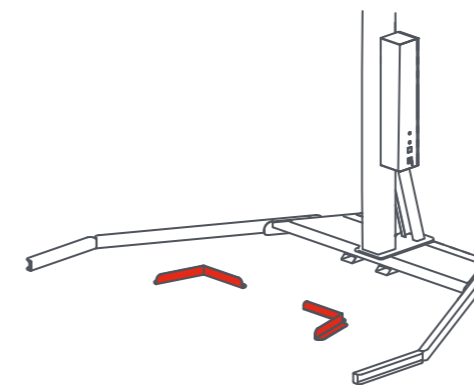

OPTIONAL

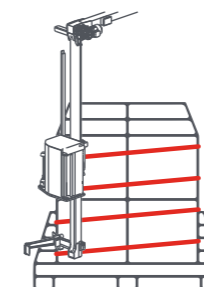
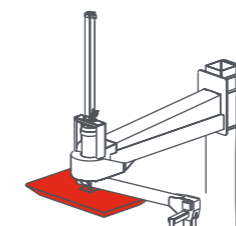
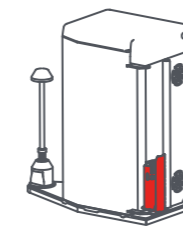

FLOOR MOUNTED GUIDES



- IT** Guida per centraggio automatico dei pallets.
- EN** Floor mounted guides to locate the pallet correctly are included.
- FR** Support de guidage pour une parfaite lecture de palette sont inclus.
- DE** Zum Lieferumfang gehört ebenfalls eine Palettenpositionierhilfe welche zeitgleich eine Kollision mit dem Dreharm ausschließt.
- ES** Soporte de guía para cargar correctamente la plataforma, incluidos en la entrega.

AUTOMATIC FILM CUT

- IT** Sistema di taglio automatico del film a fine ciclo.
- EN** Automatic Film cutting Device at cycle end.
- FR** Coupe automatique du film.
- DE** Automatische Folienschneidvorrichtung am Zyklusende.
- ES** Sistema automatico de corte film con fin de ciclo.

TOP PRESSURE UNIT

- IT** Pressore tenuta pallet
- EN** Pallet holder presser
- FR** Plateu stabilisateur de charge
- DE** Palettendruchalter
- ES** Prensor retencion palet

ROPING SYSTEM

- IT** Sistema di cordonatura film: Permette di ridurre l'altezza del film formando un cordone che assicura una più efficiente stabilizzazione del carico.
- EN** Roping System: Reducing the film width to form a rope to ensure more effective load stabilisation.
- FR** Systeme permettant de réduire la laize du film en formant un cordon qui assure une meilleure stabilisation de la charge.
- DE** Schnurrvorrichtung: Reduzierung der Folienbreite zur Schnur um eine bessere Stabilisierung der Ladung zu gewährleisten.
- ES** Sistema de Cordón. Permite reducir la altura del film formando un cordone que asegura con mas eficacia la estabilidad de la carga.

LOW TEMPERATURE MACHINE

- 6 coldstore version • -30 freezer version • inox version

SEMI AUTOMATIC RANGE

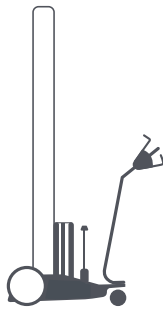

MARATHON

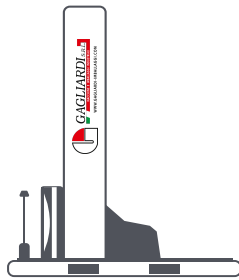

EVA

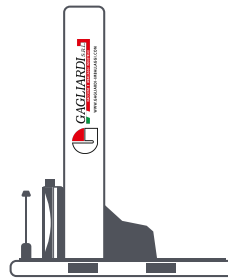

SYNTHESI

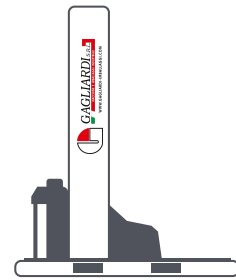

SYNTHEX

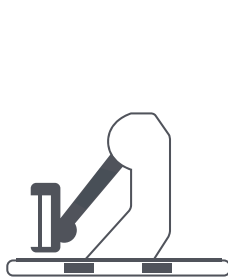

MYTHO ARM

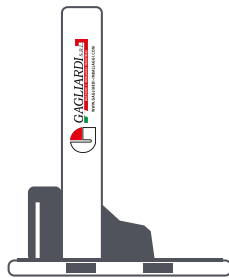

MYTHO MAST



SFERA

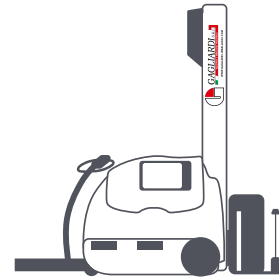

SFERA COLONNA

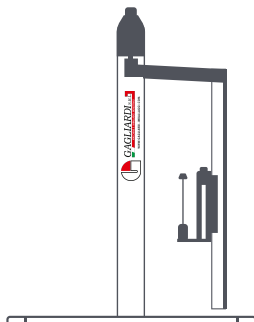

LYBRA EASY

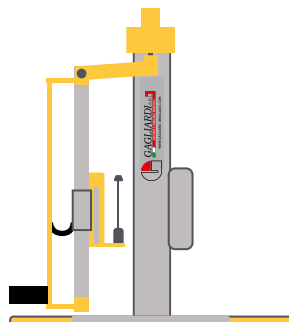

LYBRA

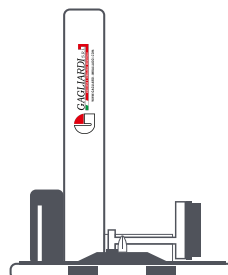

MYTHO AUTO

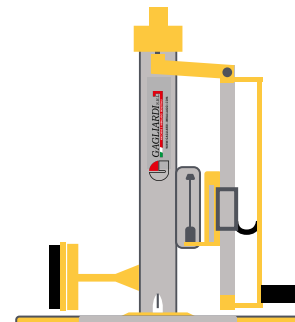

LYBRA AUTO



GAGLIARDI S.R.L.
MACCHINE E IMBALLAGGI INDUSTRIALI

WWW.GAGLIARDI-IMBALLAGGI.COM